



# *Owner's Guide*

## **Installation & Operation**

Standard/Convection Ovens  
HSO and HCO Series



**Hestan Commercial Corporation**

3375 E. La Palma Ave  
Anaheim, CA 92806  
(888) 905-7463

**RETAIN THIS MANUAL FOR FUTURE REFERENCE**



P/N 002135 REV 1

## **IMPORTANT FOR YOUR SAFETY**

THIS MANUAL HAS BEEN PREPARED FOR PERSONNEL QUALIFIED TO INSTALL GAS EQUIPMENT, WHO SHOULD PERFORM THE INITIAL FIELD START-UP AND ADJUSTMENTS OF THE EQUIPMENT COVERED BY THIS MANUAL.

POST IN A PROMINENT LOCATION THE INSTRUCTIONS TO BE FOLLOWED IN THE EVENT THE SMELL OF GAS IS DETECTED. THIS INFORMATION CAN BE OBTAINED FROM THE LOCAL GAS SUPPLIER.

## **IMPORTANT**

IN THE EVENT A GAS ODOR IS DETECTED, SHUT DOWN UNITS AT MAIN SHUTOFF VALVE AND CONTACT THE LOCAL GAS COMPANY OR GAS SUPPLIER FOR SERVICE.

## **FOR YOUR SAFETY**

DO NOT STORE OR USE GASOLINE OR OTHER FLAMMABLE VAPORS OR LIQUIDS IN THE VICINITY OF THIS OR ANY OTHER APPLIANCE.

## **WARNING**

IMPROPER INSTALLATION, ADJUSTMENT, ALTERATION, SERVICE OR MAINTENANCE CAN CAUSE PROPERTY DAMAGE, INJURY OR DEATH. READ THE INSTALLATION, OPERATING AND MAINTENANCE INSTRUCTIONS THOROUGHLY BEFORE INSTALLING OR SERVICING THIS EQUIPMENT.

IN THE EVENT OF A POWER FAILURE, DO NOT ATTEMPT TO OPERATE THIS DEVICE.

# Table of Contents

<b>Section 1:</b>	Installation .....	4
	Installation Procedure.....	4
	Uncrating.....	4
	Location .....	4
	Clearances .....	4
	Placing Appliance .....	4
	Leveling.....	4
	Riser Installation.....	5
	Statutory Regulations .....	5
	United States of America .....	5
	Canada .....	5
	Appliances Equipped with Casters.....	6
	Gas Supply.....	7
	Gas Pressure Regulator .....	8
	Ventilation Air / Flue Connections.....	8
	Electrical Supply .....	9
	Model / Serial / Rating Plate Location .....	9
<b>Section 2:</b>	Operating Instructions.....	10
	Lighting and Shutdown Instructions.....	10
<b>Section 3:</b>	Cleaning and Maintenance.....	11
	Gas-Fired Appliances .....	11
	Service .....	12

# Installation

## Installation Procedure

### Uncrating

Check the crate for any possible damage sustained during transit. Carefully remove the appliance, removing all packing material, again check for damage. Any damage to the appliance must be reported to the carrier immediately.

### Location

Proper placement of the appliance will ensure operator convenience and satisfactory performance. Adequate clearance must be maintained so that the combustion and ventilation air is not obstructed for proper operation. A minimum front clearance of 36 inches (914 mm) must be provided for servicing. The appliance must be kept free and clear of combustible materials.

### Clearances

The following minimum clearances must be followed:

Model	COMBUSTIBLE		NON-COMBUSTIBLE	
	BACK	SIDE	BACK	SIDE
36" Oven Standard	4"	2"	0"	0"
36" Oven Convection	4"	2"	0"	0"

**NOTE: For use on combustible floor with 6" legs, or for 6" non-combustible curb mount with 3" recess.**

### Placing Appliance

Place the appliance in the required position and level by means of the adjustable legs. The surface on which the appliance is to be installed must be capable of adequately supporting the weight of the appliance.

### Leveling

For proper and safe operation, each appliance must be level. Counter units must be installed on a non-combustible surface only.

6" legs are mounted using four hex-head bolts per leg and each leg is adjustable simply by turning the inner cylinder leg, clockwise to lower and counter-clockwise to elevate.

**NOTE:** On units with ovens or double stacked ovens a carpenter's level can be used on the oven rack for front to rear leveling.

## Riser Installation

- 1) Remove back panel from riser assembly by removing mounting screws.
- 2) Remove the four bolts at the rear of the appliance holding on the side panels (two on each side, see diagram below).
- 3) Place riser on support brackets on back of the appliance.
- 4) Re-install the four bolts into the back of the appliance through the riser channels, do not tighten.
- 5) Attach the bottom supports with supplied bolts, two on each side.
- 6) Tighten the four bolts that attach riser to appliance.
- 7) Tighten the four bolts that attach riser to bottom supports.
- 8) Re-install back cover.

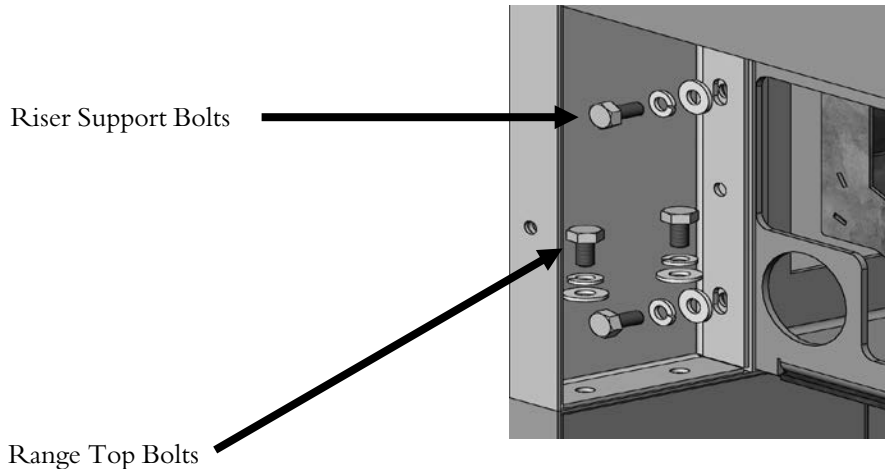

**NOTE:** Failure to re-install back cover could cause improper venting of exhaust gases/heat from the appliance, creating soot that clogs the burner(s) and flue and/or creates a temperature risk to cabinet and components.

## Statutory Regulations (Install Codes)

The installation of this appliance must be carried out by a properly trained and qualified installer and in accordance with the relevant regulations, codes of practice and the related publications of the Country, State, County and City of destination.

### United States of America

- 1) Local Codes
- 2) In the absence of local codes, installation must conform to the National Fuel Gas Code, ANSI Z223.1/NFPA 54, or the Natural Gas and Propane Installation Code, CSA B149.1, as applicable. Copies may be obtained from the American Gas Association, Inc., on their web site: <http://www.aga.org/>
- 3) National Electrical Code, ANSI/NFPA-70, or latest edition. Copies may be obtained from the National Fire Protection Association, on their web site: <http://www.nfpa.org/>
- 4) Vapor Removal From Cooking Equipment, NFPA-96, or latest edition. Copies may be obtained from the National Fire Protection Association, on their web site: <http://www.nfpa.org/>

### Canada

- 1) Local Codes
- 2) CSA B149.1 Natural Gas and Propane Installation Code.
- 3) CSA C22.1 Canadian Electrical Code
- 4) CSA C22.2 Canadian Electrical Code

Canadian codes can be found on the CSA website: <http://www.csa.ca>

## Appliances Equipped with Casters

**NOTE:** The front casters of the appliance are equipped with brakes to limit movement of the appliance without depending on the connector and any quick-disconnect device or its associated piping to limit the appliance movement.

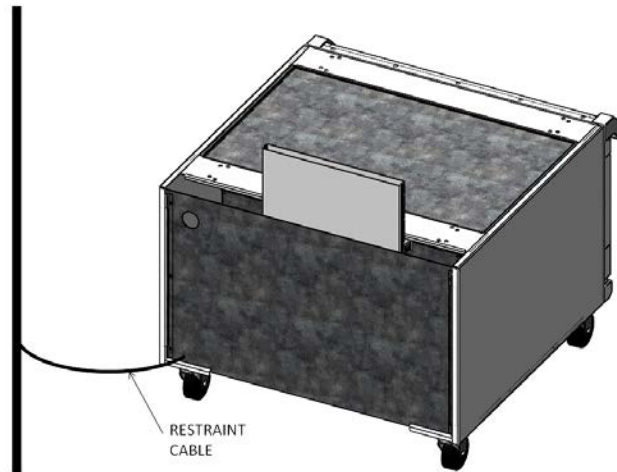

Fig. 1

- 1) The installation shall be made with a connector that complies with the Standard for Connectors for Movable Gas Appliances, ANSI Z21.69/CSA 6.16, (or latest edition), and a quick-disconnect device that complies with Standard for Quick Disconnect of Use with Gas Fuel, ANZI Z21.41/CSA 6.9, (or latest edition).
- 2) Adequate means must be provided to limit the movement of the appliance without depending on the connector and the quick-disconnect device or its associated piping to limit the appliance movement. (Fig. 1)

**NOTE:** Please be aware, required strain relief restraint cable is attached to a bracket, and if disconnection of the restraint is necessary, be sure to reconnect the restraint after the appliance has been returned to its original installed position.

## Gas Supply

The local gas authority should be consulted at the installation planning stage in order to establish the availability of an adequate supply of gas and to ensure that the meter is adequate for the required flow rate. The pipe work from the meter to the appliance must be an appropriate size.

All fixed (non-mobile) appliances must be fitted with an accessible upstream gas shutoff valve as a means of isolating the appliance for emergency shut off and for servicing. A union or similar means of disconnection must be provided between the gas-cock and the appliance.

A manually operable valve must be fitted to the gas supply to the kitchen to enable it to be isolated in an emergency. Wherever practical, this shall be located either outside the kitchen or near an exit in a readily accessible position.

Where it is not practical to do this, an automatic isolation valve system should be fitted which can be operated from a readily accessible position near the exit.

In locations where the manual isolation valve is fitted or the automatic system can be reset this notice must be posted:

**“ALL DOWNSTREAM BURNER AND PILOT VALVES MUST BE TURNED OFF PRIOR TO ATTEMPTING TO RESTORE THE SUPPLY. AFTER EXTENDED SHUT OFF, PURGE BEFORE RESTORING GAS”**

**NOTE:** Before assembly and connection, check gas supply.

### Gas Supply Notes

- 1) The type of gas for which the unit is equipped is stamped on the rating plate, see locations on page 9. Connect a unit stamped “NAT” only to natural gas and stamped “LP” only to propane gas.
- 2) If it is a new installation, have the gas authorities check the meter size and piping to assure that the unit is supplied with the necessary amount of gas supply and pressure to operate the unit(s).
- 3) Make certain new piping and connections have been made in a clean manner and have been purged so that piping compound, chips, etc. will not clog pilots, valves, gas regulator, or burners. Use pipe joint compound approved for natural and liquefied petroleum gases.
- 4) The natural gas pressure coming into the regulator should be 7” WC or .25 psig (1.75kpa) and 5” WC .18 psig (1.25kpa) coming out of the regulator. For liquid propane gas pressure coming into the regulator should be 11” WC or .4 psig (2.75kpa) and 10” WC .36 psig (2.5kpa) coming out of the regulator.

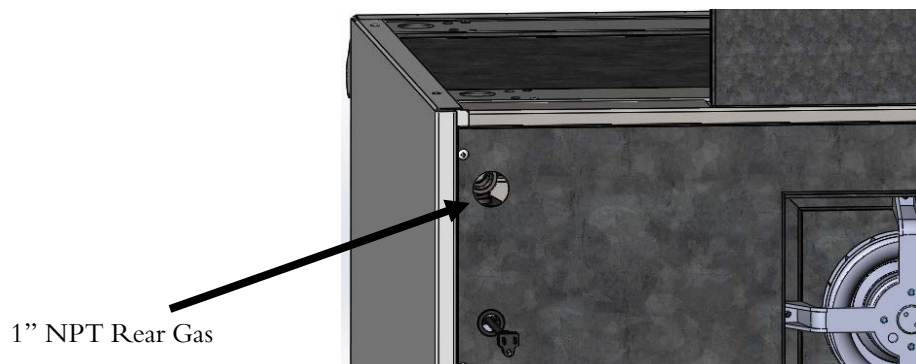

## Gas Pressure Regulator

A gas pressure regulator must be installed to regulate the proper flow of gas to the appliance. The regulator must be installed between the main gas supply line to the unit shut off valve and the appliance and must be accessible for servicing. Proper sizing of the regulator is extremely important, check the BTU rating of the appliance or appliances being regulated by the regulator.

**NOTE:** Contact the factory for regulator sizing when multiple appliances are being installed in a line up or island suite configuration and are interconnected using the front manifold connections.

**NOTE:** Gas pressure should be checked when the unit is installed and all other equipment on the same line is on. The operating gas pressure must be the same as that specified on the rating plate. If necessary, pressure adjustment may be made at the pressure regulator.

The appliance and its individual shutoff valve must be disconnected from the gas supply piping system during any pressure testing of that system where pressures are in excess of .5 psig (3.45kpa).

When test pressures are .5 psig (3.45kpa) or less, the appliance must be isolated from the gas supply system by closing its individual manual shutoff valve.



**Prior to lighting, check all joints in the gas supply line for leaks. Use soap and water solution. Do not use an open flame. After piping has been checked for leaks, all piping receiving gas should be fully purged to remove air.**

## Ventilation Air / Flue Connections

The following notes are intended to give general guidance. For detailed recommendations, refer to the applicable codes in the Country, State, County and City of installation.



**Do not obstruct the flow of combustion and ventilation air.**

Proper ventilation is critical for optimum performance. The ideal method of ventilating gas fired equipment is the use of properly designed canopy that should extend six inches (152mm) beyond all sides of the appliance (s) and six feet six inches (1981mm) above the floor. Information on the construction and installation of ventilating hoods may be obtained from the standard for "Vapor Removal from Cooking Equipment," NFPA No. 96 (latest edition), available from the National Fire Protection Association, on their web site: <http://www.nfpa.org/>.

A strong exhaust will create a vacuum in the room. For an exhaust vent to work properly, replacement air must be equal to the amount of air exhausted. An imbalance between exhaust and replacement air can cause degradation in the appliance's performance.

All gas burners and pilots need sufficient air to operate. Large objects should not be placed in front of the appliance(s) that would obstruct the flow of air into the front.

**NOTICE:** In the Commonwealth of Massachusetts all gas appliances vented by either mechanical systems or ventilation hoods shall comply with 248 CMR interlocking requirements.



## Electrical Supply (Where Applicable)

**Important:** This appliance must be electrically grounded in accordance with local codes, or in the absence of local codes with the National Electrical Code.

### **⚠ WARNING**

Appliances equipped with a flexible electrical supply cord are provided with a three-prong grounding plug. It is imperative that this plug be connected into a properly grounded three-prong receptacle. If the receptacle is not the proper grounding type, contact an electrician. Do not remove the grounding prong from this plug.

## Model / Serial / Rating Plate Locations

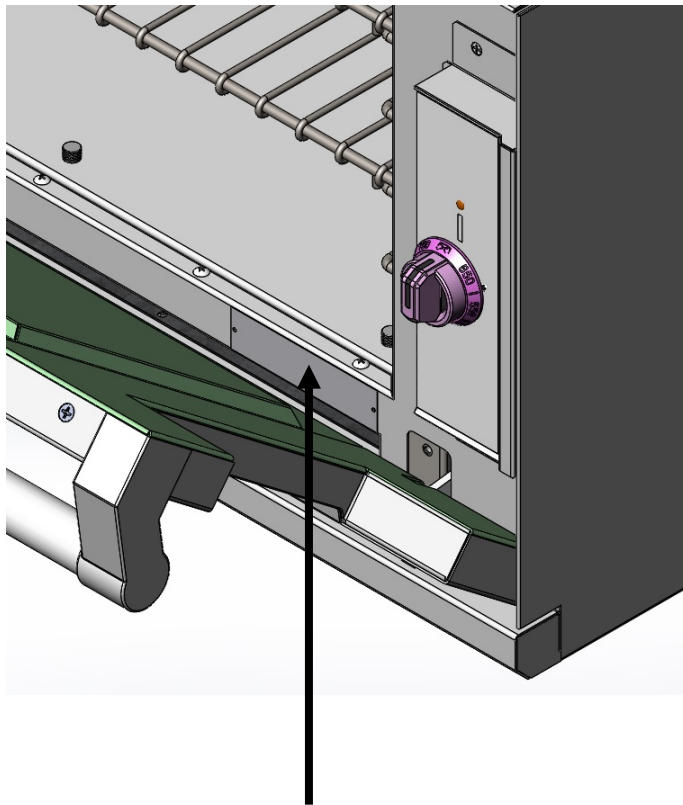

### **Range tops**

Rating plate will be located above the front panel, left side.

# Operator's Instruction

## Lighting Instructions

### Oven, Standard and Convection

- 1) Set oven thermostat to desired cooking temperature, once dial is turned to any temperature the indicator light will activate and the ovens intermittent pilot and gas valve will open. Once the oven reaches the desired temperatures the light, pilot and gas will turn off until recovery is needed.

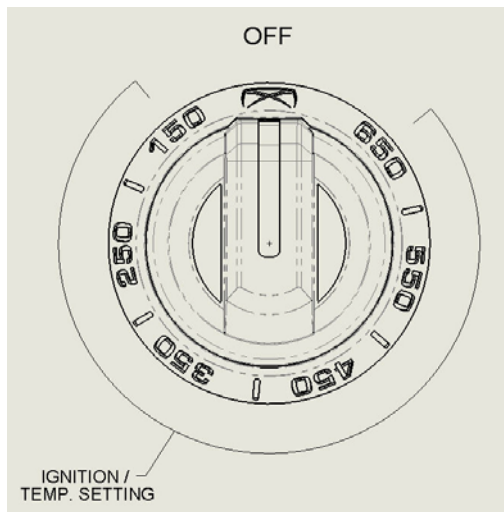

**For daily shutoff:** Turn oven dial to the "OFF" position, this will shut off the gas supply as well as shut down the ovens intermittent pilot.

**⚠ WARNING** A 5 minute complete shutoff period is required before the appliance is re-lighted



# Cleaning and Maintenance

## Gas Fired Appliances

	<b>CAUTION</b>	<b>TO AVOID RISK OF PERSONAL INJURY, BURNS OR DAMAGING UNIT</b> Do not use spray bottle to apply cleaners, over spray could cause damage to equipment. Care should be taken around burner valves and thermostat to prevent soap/degreaser from getting into valve body and mixing with valve grease.
	<b>CAUTION</b>	<b>TO AVOID RISK OF PERSONAL INJURY OR BURNS</b> Allow unit to cool prior to cleaning. If equipment has electrical power running to it disconnect power before cleaning or servicing.

### 1. Remove oven rack(s) and supports

- Use degreaser or oven cleaner on racks to clean, a stiff bristle brush or plastic scouring pad can be used to remove baked on food particles, rinse with warm clean water and dry thoroughly.
- Dry thoroughly, do not reinstall wet.

### 2. Oven interior

- Using a sponge or cloth towel, apply degreaser or oven cleaner to sidewalls, ceiling and oven door interior, allow ample time for cleaning solution to soften cooked on food particles. A plastic scraper, scouring pad or stiff bristle brush can be used to remove baked on food particles.
- **DO NOT USE STEEL WOOL OR STEEL CLEANING TOOLS ON STAINLESS STEEL SURFACES – THEY COULD LEAVE STEEL PARTICLES BEHIND IMBEDDED IN THE SURFACE AND RUST.**
- Wipe out interior and oven door with a clean sponge or towel and water, dry with clean towel.
- Remove thumb screws on ovens stainless steel bottom and remove the bottom cleaning up any remaining cleaning solution that may have gotten under the tray. Clean the oven bottom with degreaser or oven cleaner in the same way the oven interior was done.
- Thoroughly dry and reinstall oven bottom.
- Inspect flue for grease and debris build up periodically, a dirty or plugged flue could cause unit to not operate properly and allow build up of soot creating an unsafe environment.
- Remove any debris from flue opening, have a qualified technician and or cleaning service clean flue of any excess grease.

**NOTE:** Where necessary use stainless steel, wood, plastic or rubber tools to scrape off heavy deposits of grease and oil from any stainless steel equipment. This will help avoid any steel particles from becoming embedded into the stainless steel surfaces. To maintain the luster of stainless steel surfaces, apply a thin coat of stainless steel cleaner, and wipe with a clean cotton cloth, do not apply while the oven is hot. To avoid heat tint (slight oxidation which results in darkened areas in equipments stainless steel) never use more heat on any equipment than is absolutely necessary. Heat tint can be removed by scouring with stainless steel wool or scouring powder. Rub in direction of polished lines.

## *Service*

All warranty and non-warranty repairs should be performed by qualified service personnel. To locate an authorized service agent in your area contact your dealer, local representative, or the manufacturer.

**Hestan Commercial Products**  
**(888) 905-7463**